

Made in Taiwan

Since 1978

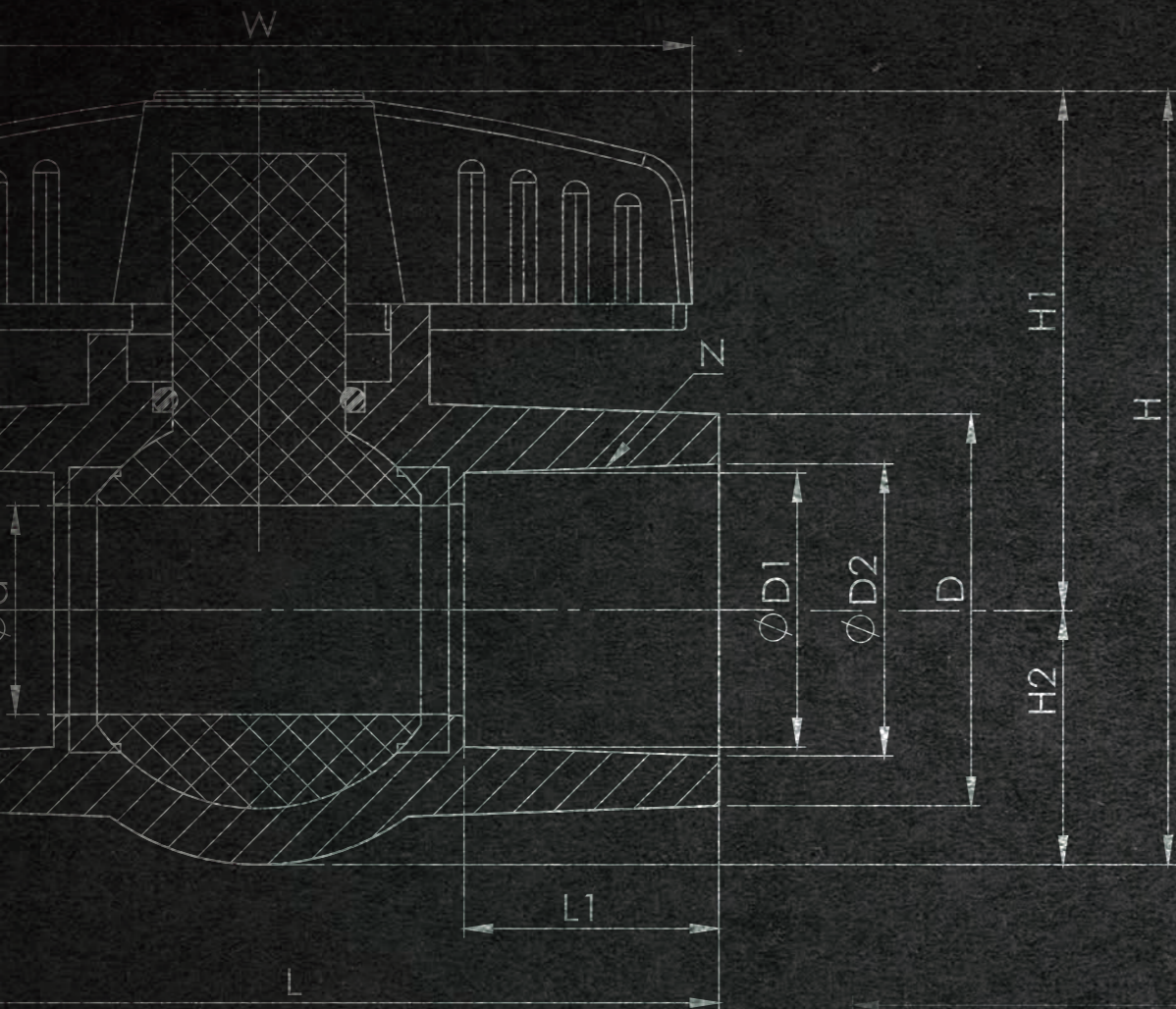

TEL : 04-7616616 | FAX : 04-7616615

地址：彰化縣秀水鄉雅興街178巷20號

E-Mail : mail@chiutong.com

網址 : http://chiutong.com

久統塑膠 X 2019

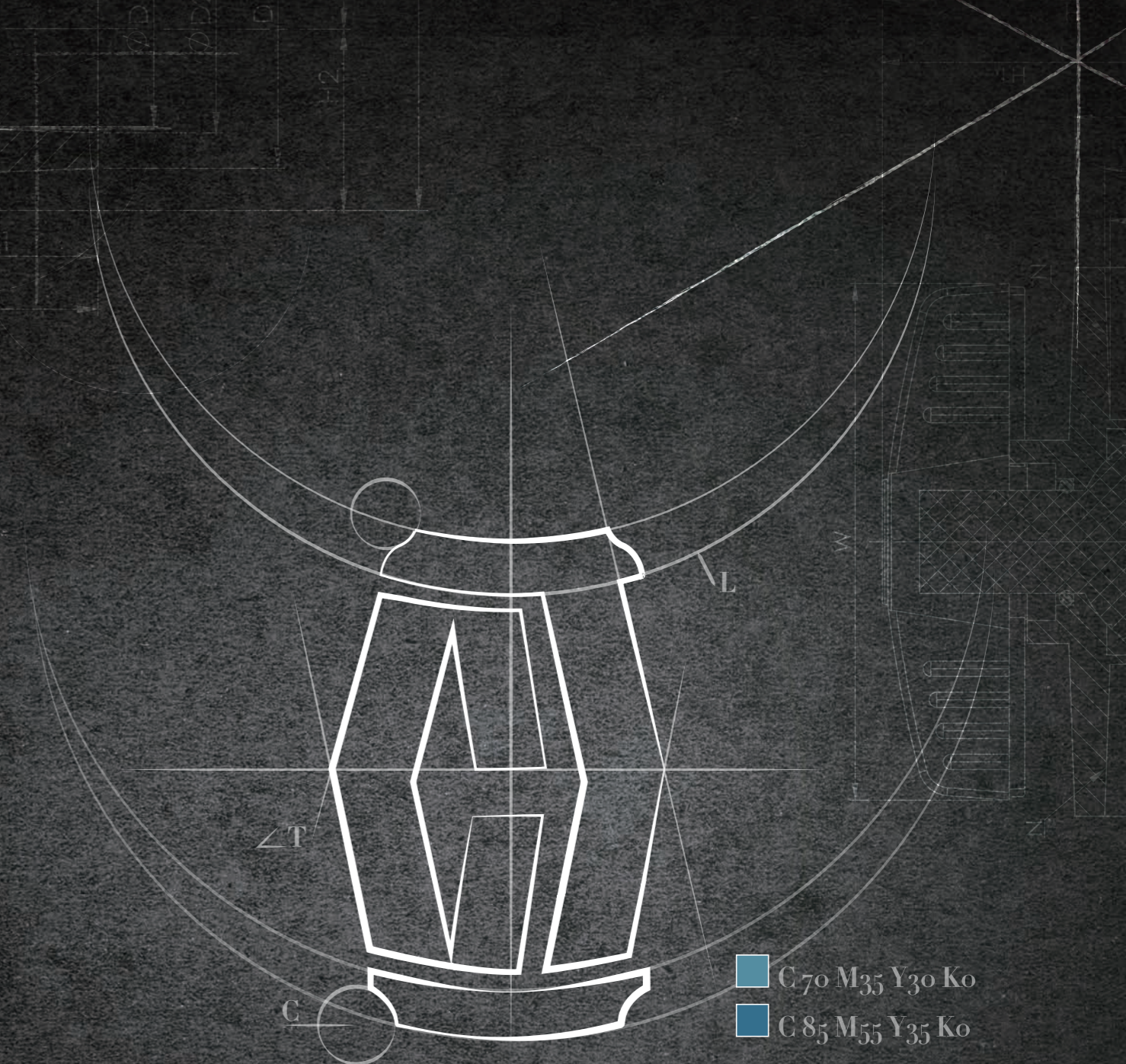

久統塑膠有限公司

CHIUTONG

We only pursue perfection







2019

CHIUTONG





產  
品  
清  
單  
Product List

參考圖	品編	品名	盒 / 箱	牌價	折數
	010300	標準型球閥 3/8"	65   390	80	
	010400	標準型球閥 1/2"	65   390	60	
	010600	標準型球閥 3/4"	40   240	80	
	011000	標準型球閥 1"	20   120	120	
	011200	標準型球閥 1 1/4"	12   72	180	
	011400	標準型球閥 1 1/2"	8   48	230	
	012000	標準型球閥 2"	5   30	320	
	020300	組合式球閥 3/8"	40   240	48	
	020400	組合式球閥 1/2"	40   240	48	
	020600	組合式球閥 3/4"	25   150	68	
	021000	組合式球閥 1"	16   96	90	
	021200	組合式球閥 1 1/4"	10   60	135	
	021400	組合式球閥 1 1/2"	6   36	200	
	022000	組合式球閥 2"	4   24	270	
	022400	組合式球閥 2 1/2"	1   16	750	
	023000	組合式球閥 3"	1   12	820	
	023900	組合式球閥 3" 小流量	1   16	800	
	023400	組合式球閥 3 1/2"	1   12	1300	
	024000	組合式球閥 4"	1   6	1600	
	024900	組合式球閥 4" 小流量	1   12	1300	
	025900	組合式球閥 5"	1   6	1700	
	026000	組合式球閥 6"	1   3	5300	
	026900	組合式球閥 6" 小流量	1   4	2600	
	030400	ST把手鋼珠球閥 1/2"	40   240	100	
	030600	ST把手鋼珠球閥 3/4"	25   150	130	
	031000	ST把手鋼珠球閥 1"	16   96	160	
	031200	ST把手鋼珠球閥 1 1/4"	10   60	330	
	031400	ST把手鋼珠球閥 1 1/2"	6   36	450	
	032000	ST把手鋼珠球閥 2"	4   24	580	
	032400	ST把手鋼珠球閥 2 1/2"	1   8	1400	
	033000	ST把手鋼珠球閥 3"	1   6	2000	
	033900	ST把手鋼珠球閥 3" 小流量	1   8	1800	
	033400	ST把手鋼珠球閥 3 1/2"	1   6	2500	
	034000	ST把手鋼珠球閥 4"	1   6	3000	
	034900	ST把手鋼珠球閥 4" 小流量	1   6	2600	
	035900	ST把手鋼珠球閥 5"	1   6	3100	
	036000	ST把手鋼珠球閥 6"	1   3	11000	
	036900	ST把手鋼珠球閥 6" 小流量	1   4	4600	
	040400	ST把手塑膠球閥 1/2"	40   240	100	
	040600	ST把手塑膠球閥 3/4"	25   150	120	
	041000	ST把手塑膠球閥 1"	16   96	150	
	041200	ST把手塑膠球閥 1 1/4"	10   60	310	
	041400	ST把手塑膠球閥 1 1/2"	6   36	380	
	042000	ST把手塑膠球閥 2"	4   24	480	
	042400	ST把手塑膠球閥 2 1/2"	1   8	1200	
	043000	ST把手塑膠球閥 3"	1   6	1800	
	043900	ST把手塑膠球閥 3" 小流量	1   8	1500	
	043400	ST把手塑膠球閥 3 1/2"	1   6	2100	
	044000	ST把手塑膠球閥 4"	1   6	2400	
	044900	ST把手塑膠球閥 4" 小流量	1   6	2200	
	045900	ST把手塑膠球閥 5"	1   6	2500	
	046000	ST把手塑膠球閥 6"	1   3	7700	
	046900	ST把手塑膠球閥 6" 小流量	1   4	4600	

參考圖	品編	品名	盒 / 箱	牌價	折數
	050400	外牙鋼珠球閥 1/2"	40   240	120	
	050600	外牙鋼珠球閥 3/4"	25   150	130	
	051000	外牙鋼珠球閥 1"	16   96	160	
	051400	外牙鋼珠球閥 1 1/2"	6   36	450	
	052000	外牙鋼珠球閥 2"	4   24	580	
	051006	外牙鋼珠球閥 1" 牙× 3/4"	25   150	150	
	051410	外牙鋼珠球閥 1 1/2" 牙× 1"	16   96	180	
	052014	外牙鋼珠球閥 2" 牙× 1 1/2"	6   36	550	
	060300	新型球閥 3/8"		55	
	060400	新型球閥 1/2"		55	
	060600	新型球閥 3/4"		75	
	061000	新型球閥 1"		95	
	061200	新型球閥 1 1/4"		150	
	061400	新型球閥 1 1/2"		220	
	062000	新型球閥 2"		290	
	070400	外牙組合式球閥 1/2"	40   240	60	
	070600	外牙組合式球閥 3/4"	25   150	80	
	071000	外牙組合式球閥 1"	16   96	100	
	071400	外牙組合式球閥 1 1/2"	6   36	210	
	072000	外牙組合式球閥 2"	4   24	300	
	071006	外牙組合式球閥 1" 牙× 3/4"	25   150	85	
	071410	外牙組合式球閥 1 1/2" 牙× 1"	16   96	135	
	072014	外牙組合式球閥 2" 牙× 1 1/2"	6   36	240	
	090400	CPVC球閥 1/2"	65   390		
	090600	CPVC球閥 3/4"	40   240		
	091000	CPVC球閥 1"	20   120		
	091200	CPVC球閥 1 1/4"	12   72		
	091400	CPVC球閥 1 1/2"	8   48		
	092000	CPVC球閥 2"	5   30		
	100400	雙由令球閥 1/2"	1   120	160	
	100600	雙由令球閥 3/4"	1   80	213	
	101000	雙由令球閥 1"	1   60	341	
	101200	雙由令球閥 1 1/4"	1   50	480	
	101400	雙由令球閥 1 1/2"	1   36	618	
	102000	雙由令球閥 2"	1   30	917	
	102400	雙由令球閥 2 1/2"	1   6	1312	
	102900	雙由令球閥 2 1/2" 小流量	1   8	1706	
	103000	雙由令球閥 3"	1   6	3370	
	104000	雙由令球閥 4"	1   4	6272	
	101080	外牙雙由令球閥 1"	60	180	
	101480	外牙雙由令球閥 1 1/2"	24	390	
	102080	外牙雙由令球閥 2"	13	620	
	110400	單由令球閥 1/2"	160	62	
	110600	單由令球閥 3/4"	112	90	
	111000	單由令球閥 1"	60	135	
	111200	單由令球閥 1 1/4"	48	200	
	111400	單由令球閥 1 1/2"	27	310	
	112000	單由令球閥 2"	16	490	
	112400	單由令球閥 2 1/2"	8	850	
	113000	單由令球閥 3"	4	1600	
	114000	單由令球閥 4"	2	2850	



參考圖	品編	品名	盒 / 箱	牌價	折數
	110670	單由令球閥 3/4" 內牙*外牙 (F*M)	130	53	
	111070	單由令球閥 1" 內牙*外牙 (F*M)	80	80	
	111270	單由令球閥 1 1/4" 內牙*外牙 (F*M)	56	120	
	111470	單由令球閥 1 1/2" 內牙*外牙 (F*M)	36	180	
	112070	單由令球閥 2" 內牙*外牙 (F*M)	20	305	
	113070	單由令球閥 3" 內牙*外牙 (F*M)	5	970	
	114070	單由令球閥 4" 內牙*外牙 (F*M)	2	2020	
	111461	外牙單由令球閥 1-1/2" 外牙*內管 (M*S)	24	290	
	112061	外牙單由令球閥 2" 外牙*內管 (M*S)	13	480	
	111471	外牙單由令球閥 1-1/2" 外牙*內牙 (M*F)	24	290	
	112071	外牙單由令球閥 2" 外牙*內牙 (M*F)	13	480	
	110662	水箱閥門 3/4" 內管*外牙 (S*M)	90	90	
	111062	水箱閥門 1" 內管*外牙 (S*M)	60	210	
	110672	水箱閥門 3/4" 內牙*外牙 (F*M)	90	90	
	111072	水箱閥門 1" 內牙*外牙 (F*M)	60	210	
	120400	CPVC雙由令球閥 1/2"	1   120	280	
	120600	CPVC雙由令球閥 3/4"	1   80	380	
	121000	CPVC雙由令球閥 1"	1   60	580	
	121200	CPVC雙由令球閥 1 1/4"	1   50	900	
	121400	CPVC雙由令球閥 1 1/2"	1   36	1220	
	122000	CPVC雙由令球閥 2"	1   30	1645	
	122400	CPVC雙由令球閥 2 1/2"	1   6	3070	
	122490	CPVC雙由令球閥 2 1/2" 小流量	1   8	2800	
	123000	CPVC雙由令球閥 3"	1   6	5270	
	124000	CPVC雙由令球閥 4"	1   4	9580	
	130400	齒輪式雙由令球閥 1/2"			
	130600	齒輪式雙由令球閥 3/4"			
	131000	齒輪式雙由令球閥 1"			
	131200	齒輪式雙由令球閥 1 1/4"			
	131400	齒輪式雙由令球閥 1 1/2"			
	132000	齒輪式雙由令球閥 2"			
	132400	齒輪式雙由令球閥 2 1/2"			
	133000	齒輪式雙由令球閥 3"			
	134000	齒輪式雙由令球閥 4"			
		140400	電動雙由令球閥 1/2" 無手動裝置		
140600		電動雙由令球閥 3/4" 手動裝置			
141000		電動雙由令球閥 1" 手動裝置			
141200		電動雙由令球閥 1 1/4" 手動裝置			
141400		電動雙由令球閥 1 1/2" 手動裝置			
142000		電動雙由令球閥 2" 手輪裝置			
142400		電動雙由令球閥 2 1/2" 手輪裝置			
143000		電動雙由令球閥 3" 手輪裝置			
144000		電動雙由令球閥 4" 手輪裝置			
		150400	單動氣動雙由令球閥 1/2"		
	150600	單動氣動雙由令球閥 3/4"			
	151000	單動氣動雙由令球閥 1"			
	151200	單動氣動雙由令球閥 1 1/4"			
	151400	單動氣動雙由令球閥 1 1/2"			
	152000	單動氣動雙由令球閥 2"			

參考圖	品編	品名	盒 / 箱	牌價	折數	
	152400	單動氣動雙由令球閥 2 1/2"				
	153000	單動氣動雙由令球閥 3"				
	154000	單動氣動雙由令球閥 4"				
	160400	雙動氣動雙由令球閥 1/2"				
	160600	雙動氣動雙由令球閥 3/4"				
	161000	雙動氣動雙由令球閥 1"				
	161200	雙動氣動雙由令球閥 1 1/4"				
	161400	雙動氣動雙由令球閥 1 1/2"				
	162000	雙動氣動雙由令球閥 2"				
	162400	雙動氣動雙由令球閥 2 1/2"				
	163000	雙動氣動雙由令球閥 3"				
	164000	雙動氣動雙由令球閥 4"				
		170400	法蘭式雙由令球閥 1/2"			
		170600	法蘭式雙由令球閥 3/4"			
		171000	法蘭式雙由令球閥 1"			
		171200	法蘭式雙由令球閥 1 1/4"			
171400		法蘭式雙由令球閥 1 1/2"				
172000		法蘭式雙由令球閥 2"				
173000		法蘭式雙由令球閥 3"				
174000		法蘭式雙由令球閥 4"				
	180400	三通球閥 1/2"				
	180600	三通球閥 3/4"				
	181000	三通球閥 1"				
	181200	三通球閥 1 1/4"				
	181400	三通球閥 1 1/2"				
	182000	三通球閥 2"				
	190660	灌溉閥門 3/4" 內管*外牙 (S*M)	130	54		
	191060	灌溉閥門 1" 內管*外牙 (S*M)	80	82		
	191460	灌溉閥門 1 1/2" 內管*外牙 (S*M)	36	185		
	192060	灌溉閥門 2" 內管*外牙 (S*M)	20	330		
	190670	灌溉閥門 3/4" 內牙*外牙 (F*M)	130	48		
	191070	灌溉閥門 1" 內牙*外牙 (F*M)	80	72		
	191470	灌溉閥門 1 1/2" 內牙*外牙 (F*M)	36	170		
	192070	灌溉閥門 2" 內牙*外牙 (F*M)	20	300		
	191090	灌溉閥門 1" 內牙*內牙 (F*F)	80	72		
	191490	灌溉閥門 1 1/2" 內牙*內牙 (F*F)	36	160		
	192090	灌溉閥門 2" 內牙*內牙 (F*F)	20	270		
	193090	灌溉閥門 3" 內牙*內牙 (F*F)	5	700		
	194090	灌溉閥門 4" 內牙*內牙 (F*F)	2	1400		
		200600	重力式逆止閥 3/4"	100	75	
201000		重力式逆止閥 1"	80	80		
201200		重力式逆止閥 1 1/4"	40	110		
201400		重力式逆止閥 1 1/2"	40	130		
202000		重力式逆止閥 2"	32	170		

中間凡而、水夾仔



參考圖	品編	品名	盒 / 箱	牌價	折數
	212400	擺動式逆止閥-鍍鋅 2 1/2"	1   24	420	
	213000	擺動式逆止閥-鍍鋅 3"	1   12	620	
	213001	擺動式逆止閥-白鐵 3"	1   12	830	
	214000	擺動式逆止閥-鍍鋅 4"	1   12	820	
	214001	擺動式逆止閥-白鐵 4"	1   12	1050	
	215001	擺動式逆止閥-白鐵 5"	1   4	<b>實價</b>	
	216001	擺動式逆止閥-白鐵 6"	1   4	5300	
	220400	彈簧式逆止閥 1/2"	1   120	56	
	220600	彈簧式逆止閥 3/4"	1   100	60	
	221000	彈簧式逆止閥 1"	1   60	74	
	221200	彈簧式逆止閥 1 1/4"	1   40	110	
	221400	彈簧式逆止閥 1 1/2"	1   40	150	
	222000	彈簧式逆止閥 2"	1   40	200	
	222400	彈簧式逆止閥 2 1/2"	1   24	400	
	223000	彈簧式逆止閥 3"	1   18	540	
	224000	彈簧式逆止閥 4"	1   8	900	
	230400	由令式逆止閥 1/2"	120	<b>50</b>	
	230600	由令式逆止閥 3/4"	100	<b>55</b>	
	231000	由令式逆止閥 1"	60	<b>70</b>	
	231200	由令式逆止閥 1 1/4"	40	100	
	231400	由令式逆止閥 1 1/2"	40	140	
	232000	由令式逆止閥 2"	40	190	
	232400	由令式逆止閥 2 1/2"	24	360	
	233000	由令式逆止閥 3"	18	500	
	240400	雙由令球型逆止閥 1/2"		<b>500</b>	
	240600	雙由令球型逆止閥 3/4"		<b>560</b>	
	241000	雙由令球型逆止閥 1"		<b>750</b>	
	241200	雙由令球型逆止閥 1 1/4"		<b>1132</b>	
	241400	雙由令球型逆止閥 1 1/2"		<b>1200</b>	
	242000	雙由令球型逆止閥 2"		<b>1560</b>	
	242400	雙由令球型逆止閥 2 1/2"		<b>2068</b>	
	243000	雙由令球型逆止閥 3"		<b>3600</b>	
244000	雙由令球型逆止閥 4"		<b>7364</b>		
	252400	法蘭口逆止閥-鍍鋅 2 1/2"	12	945	
	253000	法蘭口逆止閥-鍍鋅 3"	12	1300	
	253001	法蘭口逆止閥-白鐵 3"	12	1480	
	254000	法蘭口逆止閥-鍍鋅 4"	12	1800	
	254001	法蘭口逆止閥-白鐵 4"	12	1980	
	255001	法蘭口逆止閥-白鐵 5"	4	<b>實價</b>	
	256001	法蘭口逆止閥-白鐵 6"	4	7560	
	260400	CPVC擺動逆止閥(法蘭口) 1/2"			
	260600	CPVC擺動逆止閥(法蘭口) 3/4"			
	261000	CPVC擺動逆止閥(法蘭口) 1"			
	261400	CPVC擺動逆止閥(法蘭口) 1 1/2"			
	262000	CPVC擺動逆止閥(法蘭口) 2"			
	262400	CPVC擺動逆止閥(法蘭口) 2 1/2"			
	263000	CPVC擺動逆止閥(法蘭口) 3"			
	264000	CPVC擺動逆止閥(法蘭口) 4"			
	266000	CPVC擺動逆止閥(法蘭口) 6"			
268000	CPVC擺動逆止閥(法蘭口) 8"				

中間凡而、水夾仔

橫式逆止

同彈簧式逆止(無彈簧)

參考圖	品編	品名	盒 / 箱	牌價	折數
	270600	雙截式逆止閥 3/4"			
	271000	雙截式逆止閥 1"			
	271400	雙截式逆止閥 1 1/2"			
	272000	雙截式逆止閥 2"			
	281400	雙由令逆止閥 1 1/2"	28	<b>410</b>	
	282000	雙由令逆止閥 2"	15	<b>730</b>	
	291400	單由令逆止閥 1 1/2"	32	<b>305</b>	
	292000	單由令逆止閥 2"	16	<b>510</b>	
	290409	法蘭式單由令逆止閥 1/2"			
	290609	法蘭式單由令逆止閥 3/4"			
	291009	法蘭式單由令逆止閥 1"			
	291209	法蘭式單由令逆止閥 1 1/4"			
	291409	法蘭式單由令逆止閥 1 1/2"			
	292009	法蘭式單由令逆止閥 2"			
	293009	法蘭式單由令逆止閥 3"			
	294009	法蘭式單由令逆止閥 4"			
	296009	法蘭式單由令逆止閥 6"			
	300600	套管底閥 3/4"	1   120	54	
	301000	套管底閥 1"	1   100	70	
	301200	套管底閥 1 1/4"	1   100	110	
	301400	套管底閥 1 1/2"	1   40	140	
	302000	套管底閥 2"	1   40	170	
	303000	套管底閥 3"	1   24	540	
	312400	擺動式底閥-鍍鋅 2 1/2"	1   12	420	
	313000	擺動式底閥-鍍鋅 3"	1   12	620	
	313001	擺動式底閥-白鐵 3"	1   12	800	
	314000	擺動式底閥-鍍鋅 4"	1   12	820	
	314001	擺動式底閥-白鐵 4"	1   12	1050	
	315001	擺動式底閥-白鐵 5"	1   4	<b>實價</b>	
	316001	擺動式底閥-白鐵 6"	1   4	5900	
	322400	法蘭口底閥-鍍鋅 2 1/2"	12	980	
	323000	法蘭口底閥-鍍鋅 3"	12	1060	
	323001	法蘭口底閥-白鐵 3"	12	1225	
324000	法蘭口底閥-鍍鋅 4"	12	1560		
324001	法蘭口底閥-白鐵 4"	12	1780		
325001	法蘭口底閥-白鐵 5"	4	<b>實價</b>		
326001	法蘭口底閥-白鐵 6"	4	7800		
	330400	雙由令球型底閥 1/2"		590	
	330600	雙由令球型底閥 3/4"		680	
	331000	雙由令球型底閥 1"		915	
	331200	雙由令球型底閥 1 1/4"		1240	
	331400	雙由令球型底閥 1 1/2"		1330	
	332000	雙由令球型底閥 2"		1700	
	341200	進水管底閥 1 1/4"			
	341400	進水管底閥 1 1/2"	48		
	342000	進水管底閥 2"	50		
	342400	進水管底閥 2 1/2"	12		
	343000	進水管底閥 3"	12		
	344000	進水管底閥 4"	12		

直行中間

花籃





花籃



參考圖	品編	品名	盒 / 箱	牌價	折數
	350400	福特球型凡而(直式) 1/2"	100		
	350600	福特球型凡而(直式) 3/4"	50		
	351000	福特球型凡而(直式) 1"	24		
	351200	福特球型凡而(直式) 1 1/4"	24		
	351400	福特球型凡而(直式) 1 1/2"	24		
	352000	福特球型凡而(直式) 2"	12		
	352400	福特球型凡而(直式) 2 1/2"	8		
	353000	福特球型凡而(直式) 3"	8		
	354000	福特球型凡而(直式) 4"	4		
A type  久統品牌 台灣製	362000	把手式蝶閥 2" A款	5	2100	
	362010	把手式蝶閥 2" B款	14	1200	
	362400	把手式蝶閥 2 1/2" A款	5	2200	
	362410	把手式蝶閥 2 1/2" B款	14	1530	
	363000	把手式蝶閥 3" A款	4	2550	
	363010	把手式蝶閥 3" B款	12	2050	
	364000	把手式蝶閥 4" A款	4	3400	
	364010	把手式蝶閥 4" B款	10	2600	
	365000	把手式蝶閥 5" A款	2	5850	
	365010	把手式蝶閥 5" B款	5	3500	
B type  大陸製	366000	把手式蝶閥 6" A款	2	6700	
	366010	把手式蝶閥 6" B款	4	4600	
	368000	把手式蝶閥 8" A款	1	10300	
	368010	把手式蝶閥 8" B款	3	6200	
	372000	齒輪式蝶閥 2"			
	372400	齒輪式蝶閥 2 1/2"			
	373000	齒輪式蝶閥 3"			
	374000	齒輪式蝶閥 4"			
	375000	齒輪式蝶閥 5"			
	376000	齒輪式蝶閥 6"			
	378000	齒輪式蝶閥 8"			
	379000	齒輪式蝶閥 10"			
	379200	齒輪式蝶閥 12"			
	379400	齒輪式蝶閥 14"			
	382000	電動蝶閥 2" 手輪裝置			
	382400	電動蝶閥 2 1/2" 手輪裝置			
	383000	電動蝶閥 3" 手輪裝置			
	384000	電動蝶閥 4" 手輪裝置			
	385000	電動蝶閥 5" 手輪裝置			
	386000	電動蝶閥 6" 手輪裝置			
	388000	電動蝶閥 8" 手輪裝置			
	382080	單動氣動蝶閥 2"			
	382480	單動氣動蝶閥 2 1/2"			
	383080	單動氣動蝶閥 3"			
	384080	單動氣動蝶閥 4"			
	385080	單動氣動蝶閥 5"			
	386080	單動氣動蝶閥 6"			
	388080	單動氣動蝶閥 8"			
	382090	雙動氣動蝶閥 2"			
	382490	雙動氣動蝶閥 2 1/2"			
	383090	雙動氣動蝶閥 3"			
	384090	雙動氣動蝶閥 4"			
	385090	雙動氣動蝶閥 5"			
	386090	雙動氣動蝶閥 6"			
	388090	雙動氣動蝶閥 8"			

參考圖	品編	品名	盒 / 箱	牌價	折數
	390000	取樣閥組合 1/4" 雙內牙 (附配件)	100	260	
	390001	取樣閥組合 1/4" 內外牙 (附配件)	100	260	
	390400	排氣閥 1/2" A款	400	100	
	390600	排氣閥 3/4" A款	350	110	
	391000	排氣閥 1" A款	300	115	
	391400	排氣閥 1 1/2" A款	50	340	
	392000	排氣閥 2" A款	50	345	
	391001	排氣閥 1" B款	165	255	
	392001	排氣閥 2" B款	50	1280	
	391002	排氣閥 1" C款-小	120	480	
	391003	排氣閥 1" C款-大	50	1150	
	392002	排氣閥 2" C款	40	2250	
	400400	法蘭片-一體式 1/2" 10K	200	40	
	400600	法蘭片-一體式 3/4" 10K	100	48	
	401000	法蘭片-一體式 1" 10K	120	64	
	401200	法蘭片-一體式 1 1/4" 10K	80	95	
	401400	法蘭片-一體式 1 1/2" 10K	80	96	
	402000	法蘭片-一體式 2" 10K	60	106	
	402400	法蘭片-一體式 2 1/2" 10K	45	130	
	403000	法蘭片-一體式 3" 10K	40	160	
	404000	法蘭片-一體式 4" 10K	24	220	
	405000	法蘭片-一體式 5" 10K	18	340	
	406000	法蘭片-一體式 6" 10K	12	450	
	408000	法蘭片-一體式 8" 10K	8		
	409000	法蘭片-一體式 10" 10K	4		
	409200	法蘭片-一體式 12" 10K	2		
	409400	法蘭片-一體式 14" 10K	1		





參考圖	品編	品名	盒 / 箱	牌價	折數
	400409	盲法蘭 1/2" 10K		65	
	400609	盲法蘭 3/4" 10K		75	
	401009	盲法蘭 1" 10K		100	
	401209	盲法蘭 1 1/4" 10K		130	
	401409	盲法蘭 1 1/2" 10K		150	
	402009	盲法蘭 2" 10K		165	
	402409	盲法蘭 2 1/2" 10K		205	
	403009	盲法蘭 3" 10K		220	
	404009	盲法蘭 4" 10K		310	
	405009	盲法蘭 5" 10K		440	
	410400	法蘭膠墊-一體式 1/2" 10K		13	
	410600	法蘭膠墊-一體式 3/4" 10K		16	
	411000	法蘭膠墊-一體式 1" 10K		22	
	411200	法蘭膠墊-一體式 1 1/4" 10K		24	
	411400	法蘭膠墊-一體式 1 1/2" 10K		30	
	412000	法蘭膠墊-一體式 2" 10K		32	
	412400	法蘭膠墊-一體式 2 1/2" 10K		35	
	413000	法蘭膠墊-一體式 3" 10K		43	
	414000	法蘭膠墊-一體式 4" 10K		52	
	415000	法蘭膠墊-一體式 5" 10K		80	
	420300	快速接頭 3/8"	400		
	420400	快速接頭 1/2"	200		
	420600	快速接頭 3/4"	150		
	421000	快速接頭 1"	100		
	421200	快速接頭 1 1/4"	80		
	421400	快速接頭 1 1/2"	60		
	422000	快速接頭 2"	40		
	422400	快速接頭 2-1/2"	40		
	423000	快速接頭 3"	16		
	424000	快速接頭 4"	16		
	430400	由令 1/2"		30	
	430600	由令 3/4"		36	
	431000	由令 1"		50	
	431200	由令 1 1/4"		70	
	431400	由令 1 1/2"		100	
	432000	由令 2"		140	
	432400	由令 2 1/2"		280	
	433000	由令 3"		380	
	434000	由令 4"		640	
		431470	由令 1 1/2" FT*MT	70	135
432070		由令 2" FT*MT	36	175	

















參考圖	品編	品名	盒 / 箱	牌價	折數
	440400	水桶接頭-PE 1/2"		30	
	440600	水桶接頭-PE 3/4"	50	34	
	440601	水桶接頭-耐龍 3/4"		50	
	441000	水桶接頭-PE 1"	50	44	
	441001	水桶接頭-耐龍 1"		65	
	441400	水桶接頭-PE 1 1/2"	50	80	
	441401	水桶接頭-耐龍 1 1/2"		120	
	442000	水桶接頭-PE 2"	50	160	
	442001	水桶接頭-耐龍 2"		190	
	443000	水桶接頭-PE 3"	50	300	
	443001	水桶接頭-耐龍 3"		400	
	444000	水桶接頭-PE 4"		700	
	440402	水桶接頭-橡膠束環 1/2"	100/袋	80	
	440602	水桶接頭-橡膠束環 3/4"	100/袋	85	
	441002	水桶接頭-橡膠束環 1"	100/袋	110	
	441402	水桶接頭-橡膠束環 1-1/2"	50/袋	145	
	442002	水桶接頭-橡膠束環 2"	40/袋	185	
	443002	水桶接頭-橡膠束環 3"	120	360	
	444002	水桶接頭-橡膠束環 4"	80	470	
		440603	水塔接頭(短)-PVC 3/4"		77
	440604	通氣水塔接頭 3/4"		93	
	450604	水塔下申 3/4" × 1/2"	50	12	
	451004	水塔下申 1" × 1/2"	50	14	
	451006	水塔下申 1" × 3/4"	50	14	
	451404	水塔下申 1 1/2" × 1/2"	50	20	
	451406	水塔下申 1 1/2" × 3/4"	50	20	
	451410	水塔下申 1 1/2" × 1"	50	20	
	452004	水塔下申 2" × 1/2"	50	30	
	452006	水塔下申 2" × 3/4"	50	30	
	452010	水塔下申 2" × 1"	50	30	
	452014	水塔下申 2" × 1 1/2"	50	30	
	460401	Y型過濾器-透明 1/2"	30	1500	
	460601	Y型過濾器-透明 3/4"	30	1800	
	461001	Y型過濾器-透明 1"	30	2000	
	461201	Y型過濾器-透明 1 1/4"	10	2500	
	461401	Y型過濾器-透明 1 1/2"	10	3350	
	462001	Y型過濾器-透明 2"	5	4900	
	462401	Y型過濾器-透明 2-1/2"	1	7800	
	463001	Y型過濾器-透明 3"	1	9400	
	470400	水塔加長套銅彎頭-進水口 1/2"			
	470600	水塔加長套銅彎頭-進水口 3/4"			
	481006	水塔45°閥接頭-出水口 1" × 3/4"			
	481410	水塔45°閥接頭-出水口 1 1/2" × 1"			
	491400	防臭排水接頭 1 1/2"			
	492000	防臭排水接頭 2"			
	492400	防臭排水接頭 2-1/2"			
	493000	防臭排水接頭 3"			
	494000	防臭排水接頭 4"			
495000	防臭排水接頭 5"				



參考圖	品編	品名	盒 / 箱	牌價	折數
	500400	法蘭式隔膜閥 1/2"			
	500600	法蘭式隔膜閥 3/4"			
	501000	法蘭式隔膜閥 1"			
	501400	法蘭式隔膜閥 1-1/2"			
	502000	法蘭式隔膜閥 2"			
	502400	法蘭式隔膜閥 2-1/2"			
	503000	法蘭式隔膜閥 3"			
	504000	法蘭式隔膜閥 4"			
	506000	法蘭式隔膜閥 6"			
	508000	法蘭式隔膜閥 8"			
	510400	由令式隔膜閥 1/2"			
	510600	由令式隔膜閥 3/4"			
	511000	由令式隔膜閥 1"			
	511400	由令式隔膜閥 1-1/2"			
	512000	由令式隔膜閥 2"			
	600400	套銅彎頭 1/2" (加長)	700	7	
	600600	套銅彎頭 3/4"	500	9	
	601000	套銅彎頭 1"	300	23	
	600604	套銅彎頭 3/4" × 1/2" 牙	500	12	
	601004	套銅彎頭 1" × 1/2" 牙	450	25	
	601006	套銅彎頭 1" × 3/4" 牙	450	25	
	610400	套銅接頭 1/2" (加長)	900	7	
	610600	套銅接頭 3/4"	600	9	
	611000	套銅接頭 1"	350	23	
	610604	套銅接頭 3/4" × 1/2" 牙	600	12	
	611004	套銅接頭 1" × 1/2" 牙	350	25	
	611006	套銅接頭 1" × 3/4" 牙	350	25	
	620400	套銅三通 1/2"	500	8	
	620600	套銅三通 3/4"	350	12	
	621000	套銅三通 1"	180	30	
	620604	套銅三通 3/4" × 1/2" 牙	450	12	
	621004	套銅三通 1" × 1/2" 牙	200	25	
	621006	套銅三通 1" × 3/4" 牙	200	25	
	630400	套銅外牙接頭 1/2"	30/690	25	
	630600	套銅外牙接頭 3/4"	25/600	30	
	631000	套銅外牙接頭 1"	25/400	40	
	631200	套銅外牙接頭 1-1/4"	280	120	
	631400	套銅外牙接頭 1-1/2"	210	150	
	632000	套銅外牙接頭 2"	96	200	
	630604	套銅外牙接頭 3/4" × 1/2" 牙	25/600	30	
	640400	套銅外牙彎頭 1/2"	25/500	30	
	640600	套銅外牙彎頭 3/4"	20/380	40	
	641000	套銅外牙彎頭 1"	10/180	54	
640604	套銅外牙彎頭 3/4" × 1/2" 牙	20/380	40		
	650400	ST 束口彎頭 1/2" (加長)	25/500	34	
	650600	ST 束口彎頭 3/4"	20/400	42	
	651000	ST 束口彎頭 1"	10/150	68	
	650604	ST 束口彎頭 3/4" × 1/2" 牙	20/400	46	

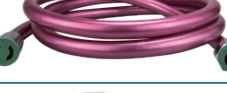











參考圖	品編	品名	盒 / 箱	牌價	折數
	660400	ST 束口接頭 1/2"	25/600	30	
	660600	ST 束口接頭 3/4"	20/400	42	
	661000	ST 束口接頭 1"	10/200	68	
	660604	ST 束口接頭 3/4" × 1/2" 牙	20/400	46	
	670400	ST 束口三通 1/2"	15/420	38	
	670600	ST 束口三通 3/4"	10/250	48	
	680400	重型套銅彎頭 1/2"	50/500	34	
	680600	重型套銅彎頭 3/4"	50/400	42	
	681000	重型套銅彎頭 1"	20/200	86	
	680000	重型套銅彎頭 3/4" × 1/2"	50/400	36	
	680401	重型套銅接頭 1/2"	100/700	30	
	680601	重型套銅接頭 3/4"	50/500	46	
	681001	重型套銅接頭 1"	50/500	86	
	680001	重型套銅接頭 3/4" × 1/2"	20/300	38	
	680402	重型套銅三通 1/2"	50/300	34	
	680602	重型套銅三通 3/4"	50/250	50	
	680002	重型套銅三通 3/4" × 1/2"	50/200	42	
	680403	重型外牙套銅接頭 1/2"	30/900	28	
	680603	重型外牙套銅接頭 3/4"	25/700	38	
	680404	重型外牙套銅彎頭 1/2"	50/450	30	
	680604	重型外牙套銅彎頭 3/4"	50/300	40	
	690400	龍口彎頭 1/2" (無加長)	1300	6.5	
	690600	龍口彎頭 3/4"	900	9	
	691000	龍口彎頭 1"	500	23	
	690000	龍口彎頭 3/4" × 1/2" 牙	1200	12	
	690401	龍口接頭 1/2" (無加長)	1700	6.5	
	690601	龍口接頭 3/4"	1200	9	
	691001	龍口接頭 1"	700	23	
	690001	龍口接頭 3/4" × 1/2" 牙	1200	12	
	690011	龍口接頭 1" × 1/2" 牙	800	25	
	690021	龍口接頭 1" × 3/4" 牙	800	25	
	690402	龍口三通 1/2"	1000	8	
	690602	龍口三通 3/4"	700	12	
	690002	龍口三通 3/4" × 1/2" 牙	850	12	
	690012	龍口三通 1" × 1/2" 牙	400	25	
	690022	龍口三通 1" × 3/4" 牙	400	25	
	690403	龍口外牙接頭 1/2"	1250	7	
	690603	龍口外牙接頭 3/4"	800	8	
	691003	龍口外牙接頭 1"	500	13	
	690404	龍口外牙彎頭 1/2"	1000	30	
	690604	龍口外牙彎頭 3/4"	750	40	
	691004	龍口外牙彎頭 1"	300	54	















參考圖	品編	品名	盒 / 箱	牌價	折數
	700000	五呎白花軟管(4分)	80		
	700001	五呎白花銅頭軟管(5分)	80		
	700002	五呎白鐵軟管(標準型)	80		
	700003	六呎白鐵軟管(標準型)			
	700004	八呎白鐵軟管(標準型)			
	700005	十呎白鐵軟管(標準型)			
	700010	五呎白鐵軟管(大流量)			
	700011	八呎白鐵軟管(大流量)			
	700020	五呎白鐵軟管(不打結)			
700021	八呎白鐵軟管(不打結)				
	700030	五呎不銹鋼軟管-加密	80		
	700040	五呎不銹鋼軟管-鍍金	80		
	700041	五呎不銹鋼軟管-玫瑰金	80		
	700042	五呎不銹鋼軟管-青古銅	80		
	700043	五呎不銹鋼軟管-黑古銅	80		
	700060	五呎PVC彩色軟管-霧銀	60		
	700061	五呎PVC彩色軟管-霧金	60		
	700062	五呎PVC彩色軟管-鍍色	60		
	700063	五呎PVC彩色軟管-水藍	60		
	700064	五呎PVC彩色軟管-鈦紫	60		
	700100	四呎噴槍平口軟管(4分)	80		
	700200	白色大壁掛(5分)	180		
	700201	白色小壁掛(4分)	280		

參考圖	品編	品名	盒 / 箱	牌價	折數
	700202	電鍍小壁掛(4分)	280		
	700203	白色調整型壁掛(5分)	180		
	700204	電鍍調整型壁掛(4分)	180		
	700209	電鍍式雙孔壁掛(4分)	180		
	700300	三通-白			
	700301	三通-銅			
	700302	三通-電鍍			
	701000	單段直管灰蓋蓮蓬頭	120		
	701004	單段直管圓灰白蓋蓮蓬頭	96		
	701006	單段直管圓灰蓋蓮蓬頭	120		
	701007	單段彎管圓灰蓋蓮蓬頭	96		
	701008	單段電鍍彎管黑蓋蓮蓬頭	96		
	701100	單段除垢直管深灰蓋蓮蓬頭	120		
	701102	單段除垢直管淺灰蓋蓮蓬頭	120		
	701104	單段除垢電鍍彎管灰蓋蓮蓬頭	96		











參考圖	品編	品名	盒 / 箱	牌價	折數
	701200	三段按摩直管藍白蓋蓮蓬頭	96		
	701201	三段按摩直管純白蓋蓮蓬頭	96		
	701202	三段式米白直管蓮蓬頭	96		
	701203	三段式電鍍彎管蓮蓬頭	96		
	701300	五段電鍍直管蓮蓬頭 (符合德國市場認證環保內管)	36		
	701301	五段按摩直管蓮蓬頭-寶石藍	42		
	701302	五段按摩直管蓮蓬頭-桃粉紅	42		
	701303	五段按摩直管蓮蓬頭-玫瑰金	42		
	701304	五段按摩直管蓮蓬頭-神秘黑	42		
	701320	八段多功能彎管蓮蓬頭	24		
	701400	單段開關蓮蓬頭(按鍵式)	160		
	701402	單段省水直管氣泡蓮蓬頭	120		
	701405	單段省水電鍍彎管氣泡蓮蓬頭	96		

參考圖	品編	品名	盒 / 箱	牌價	折數
	701500	膠囊蓮蓬頭-珍珠白(玻尿酸鈉)	60		
	701501	膠囊蓮蓬頭-玫瑰金(穀胱甘肽)	60		
	701900	亞硫酸鈣茶葉包(3入裝) 泡澡用			
	701901	亞硫酸鈣膠囊(1入裝)	90		
	701910	玻尿酸鈉凝膠球(3入裝)	150		
	701911	杜松莓果凝膠球(3入裝)	150		
	701912	歐洲越橘凝膠球(3入裝)	150		
	701913	麝香蒼蘭凝膠球(3入裝)	150		
	701914	穀胱甘肽凝膠球(3入裝)	150		
	701950	玻尿酸鈉膠囊(1入裝)	90		
	701951	杜松莓果膠囊(1入裝)	90		
	701952	歐洲越橘膠囊(1入裝)	90		
	701953	麝香蒼蘭膠囊(1入裝)	90		
	701954	穀胱甘肽膠囊(1入裝)	90		
	701999	餘氯測試劑-迷你瓶			
	702000	白色噴槍(A)	200		
	702001	白色噴槍(B)	200		
	702002	電鍍噴槍(B)	200		
	702004	電鍍噴槍(A)	200		
	702005	鳥型電鍍噴槍 (內裝白鐵軸心)			
	702010	銅噴槍			



參考圖	品編	品名	盒 / 箱	牌價	折數
	703100	兩段式氣泡廚房花灑	120		
	710000	P型落水管-伸縮加長	盒裝32 袋裝45		
	710001	S型落水管-伸縮加長	盒裝17 袋裝27		
	710007	按壓式 ST面蓋排桿-有溢水孔	90		
	710008	按壓式 ST面蓋排桿-無溢水孔	90		
	710009	按壓式落水頭	400		
	710010	P型落水管-清潔口	盒裝32 袋裝45		
	710011	S型落水管-清潔口	盒裝17 袋裝27		
	710012	萬用型落水管	盒裝32		
	710021	37CM下水管	80		
	710100	6吋鋼絲軟管 1/2"(牙)*1/2"(管)*1/2"(牙)			
	710101	8吋鋼絲軟管 1/2"(牙)*1/2"(管)*1/2"(牙)			
	710102	1呎鋼絲軟管 1/2"(牙)*1/2"(管)*1/2"(牙)			
	710103	1.2呎鋼絲軟管 1/2"(牙)*1/2"(管)*1/2"(牙)			
	710104	1.5呎鋼絲軟管 1/2"(牙)*1/2"(管)*1/2"(牙)			
	710105	2呎鋼絲軟管 1/2"(牙)*1/2"(管)*1/2"(牙)			
	710106	2.5呎鋼絲軟管 1/2"(牙)*1/2"(管)*1/2"(牙)			
	710107	3呎鋼絲軟管 1/2"(牙)*1/2"(管)*1/2"(牙)			
	710108	4呎鋼絲軟管 1/2"(牙)*1/2"(管)*1/2"(牙)			
	710109	5呎鋼絲軟管 1/2"(牙)*1/2"(管)*1/2"(牙)			

參考圖	品編	品名	盒 / 箱	牌價	折數
	710110	6呎鋼絲軟管 1/2"(牙)*1/2"(管)*1/2"(牙)			
	710111	7呎鋼絲軟管 1/2"(牙)*1/2"(管)*1/2"(牙)			
	710112	8呎鋼絲軟管 1/2"(牙)*1/2"(管)*1/2"(牙)			
	710113	9呎鋼絲軟管 1/2"(牙)*1/2"(管)*1/2"(牙)			
	710114	10呎鋼絲軟管 1/2"(牙)*1/2"(管)*1/2"(牙)			
	710120	6吋鋼絲軟管 1/2"(牙)*3/4"(管)*1/2"(牙)			
	710121	8吋鋼絲軟管 1/2"(牙)*3/4"(管)*1/2"(牙)			
	710122	1呎鋼絲軟管 1/2"(牙)*3/4"(管)*1/2"(牙)			
	710123	1.2呎鋼絲軟管 1/2"(牙)*3/4"(管)*1/2"(牙)			
	710124	1.5呎鋼絲軟管 1/2"(牙)*3/4"(管)*1/2"(牙)			
	710125	2呎鋼絲軟管 1/2"(牙)*3/4"(管)*1/2"(牙)			
	710126	2.5呎鋼絲軟管 1/2"(牙)*3/4"(管)*1/2"(牙)			
	710127	3呎鋼絲軟管 1/2"(牙)*3/4"(管)*1/2"(牙)			
	710128	4呎鋼絲軟管 1/2"(牙)*3/4"(管)*1/2"(牙)			
	710129	5呎鋼絲軟管 1/2"(牙)*3/4"(管)*1/2"(牙)			
	710130	6呎鋼絲軟管 1/2"(牙)*3/4"(管)*1/2"(牙)			
	711000	1-1/2"白鐵四角中型落水頭	200		
	711001	1-1/2"白鐵四角中型落水頭(附防蟲網)	200		
	711002	2"白鐵四角中型落水頭	200		
	711003	2"白鐵四角中型落水頭(附防蟲網)	200		
	711004	1-1/2"中型高腳落水頭	200		
	711005	1-1/2"中型高腳落水頭(附防蟲網)	200		
	711006	2"中型高腳落水頭	200		
	711007	2"中型高腳落水頭(附防蟲網)	200		
	711008	1-1/2"大型高腳落水頭	100		
	711009	1-1/2"大型高腳落水頭(附防蟲網)	100		
	711010	2"大型高腳落水頭	100		
	711011	2"大型高腳落水頭(附防蟲網)	100		
	711012	2-1/2"大型高腳落水頭	100		
	711013	2-1/2"大型高腳落水頭(附防蟲網)	100		
	711014	3"大型高腳落水頭	100		
	711015	3"大型高腳落水頭(附防蟲網)	100		
	711100	2"洗衣機兩用落水頭	50		
	711101	1-1/2"直條地板9.5*9.5(螺絲型)和成型	100		
	711102	2"直條地板9.5*9.5(螺絲型)和成型	100		
	711103	1-1/2"歐式雙層地板	100		
	711104	1-1/2"歐式雙層地板(附塑膠上不來)	100		
	711105	1-1/2"歐式雙層地板(附ST水門)	100		
	711106	2"歐式雙層地板	100		
	711107	2"歐式雙層地板(附塑膠上不來)	100		
	711108	2"歐式雙層地板(附ST水門)	100		
	711109	1-1/2"方孔地板	50		
	711110	1-1/2"方孔地板(附ST水門)	50		
	711111	1-1/2"ST水門	50		
	711112	2"方孔地板	50		
	711113	2"方孔地板(附ST水門)	50		
	711114	2"ST水門	50		



參考圖	品編	品名	盒 / 箱	牌價	折數
	711115	1-1/2"方孔地板(附ST水門)	50		
	711116	2"方孔地板(附ST水門)	50		
	711117	3"方孔地板	50		
	711118	4"方孔地板	50		
	711119	1-1/2"SUS430方孔地板 (一體式水門)			
	711120	2"SUS430方孔地板 (一體式水門)			
	711121	4"ST清潔口-圓形 (螺絲型)			
	711122	5"ST清潔口-圓形 (螺絲型)			
	711123	3"ST清潔口-方形 (螺絲型)			
	711124	4"ST清潔口-方形 (螺絲型)			
	711125	5"ST清潔口-方形 (螺絲型)			
	720000	單孔毛巾架			
	720001	雙孔毛巾架			
	731000	液面控制器	42		
	731100	ABS浮球開關組 1/2"	60		
	731101	ABS浮球開關組 3/4"	60		
	731102	ABS浮球開關組 1"	60		
	731103	ABS浮球開關組 1 1/2"	25		
	731104	ABS浮球開關組 2"	25		
	731105	ABS浮球開關組 3" (牙口)	8		
	731106	ABS浮球開關組 3" (法蘭式)	6		
731107	ABS浮球開關組 4" (法蘭式)	5			
	732000	面盆拆裝工具			
	733000	多功能陶瓷膠			
	733010	25MM玻璃纖維加強帶			
	734000	久統-PVC絕緣膠帶(紅) 0.13mm*19mm*20M	10/250		
	734001	久統-PVC絕緣膠帶(黑) 0.13mm*19mm*20M	10/250		



















參考圖	品編	品名	盒 / 箱	牌價	折數
	734002	久統-PVC絕緣膠帶(黃) 0.13mm*19mm*20M	10/250		
	734003	久統-PVC絕緣膠帶(綠) 0.13mm*19mm*20M	10/250		
	734004	久統-PVC絕緣膠帶(白) 0.13mm*19mm*20M	10/250		
	734005	久統-PVC絕緣膠帶(灰) 0.13mm*19mm*20M	10/250		
	734006	久統-PVC絕緣膠帶(藍) 0.13mm*19mm*20M	10/250		
	734009	久統-PVC絕緣膠帶(透明) 0.13mm*19mm*20M	10/250		
	734100	YEA-PVC絕緣膠帶(紅) 0.13mm*18mm*18M	10/250		
	734101	YEA-PVC絕緣膠帶(黑) 0.13mm*18mm*18M	10/250		
	734102	YEA-PVC絕緣膠帶(黃) 0.13mm*18mm*18M	10/250		
	734103	YEA-PVC絕緣膠帶(綠) 0.13mm*18mm*18M	10/250		
	734104	YEA-PVC絕緣膠帶(白) 0.13mm*18mm*18M	10/250		
	734105	YEA-PVC絕緣膠帶(灰) 0.13mm*18mm*18M	10/250		
	734106	YEA-PVC絕緣膠帶(藍) 0.13mm*18mm*18M	10/250		
	734109	YEA-PVC絕緣膠帶(透明) 0.13mm*18mm*18M	10/250		
	740400	平面牙塞頭 1/2"	100		
	740600	平面牙塞頭 3/4"	100		
	741000	平面牙塞頭 1"	100		
	740401	外牙塞頭-長 1/2"	100		
	740601	外牙塞頭-長 3/4"	100		
	740402	外牙塞頭-短 1/2"	100		
	740602	外牙塞頭-短 3/4"	100		
	741002	外牙塞頭-短 1"	100		



參考圖	品編	品名	盒 / 箱	牌價	折數
	740002	釘套 1-1/4"	85		
	740003	釘套 1"	85		
	740005	止洩帶15M	10/100		
	740006	YEA止洩帶10M	10/100		
	740007	YEA止洩帶15M	10/100		
	740101	#1 長牙塞 (要用止洩帶)	100/1200		
	740102	#2 長牙塞 (免用止洩帶)	100/1200		
	740104	#4 長牙塞-免敲牆壁 (免止洩帶)	100/1200		
	740205	#5 胖牙塞 (要用止洩帶)	100/1200		
	740206	#6 胖牙塞 (免用止洩帶)	100/1200		
	740208	#8 胖牙塞-免敲牆壁 (免止洩帶)	100/1200		
	750000	沐浴龍頭(全銅) 附蓮蓬頭			
	750001	圓柱沐浴龍頭(全銅) 附蓮蓬頭			
	750100	面盆單孔龍頭(全銅) 附按壓式排桿、P彎、三角凡而			
	750101	圓柱面盆單孔龍頭(全銅) 附拉桿式排桿、P彎、三角凡而、白鐵絲管			
	750200	單把手面盆龍頭(半銅半塑)	12		
	750201	天使雙把手面盆龍頭(半銅半塑)	6		
	750202	茶壺雙把手茶龍頭(半銅半塑)	6		

參考圖	品編	品名	盒 / 箱	牌價	折數
	751000	萬向壁式龍頭			
	751001	萬向壁式冷熱龍頭 全配(附開關彎頭)			
	751100	萬向立式龍頭			
	751101	萬向立式冷熱龍頭 全配(附鋼絲+一字外牙)			
	751102	廚房下抽龍頭(全銅) 附三角凡而			
	751103	彈簧廚房抽取式龍頭(全銅) 附三角凡而			
	751300	單把手廚房龍頭(半銅半塑)	12		
	751301	高統雙把手廚房龍頭(半銅半塑)	12		
	751302	大C天使雙把手廚房龍頭(半銅半塑)	12		



















參考圖	品編	品名	盒 / 箱	牌價	折數
	753200	不鏽鋼檯面龍頭 (附ST單孔鋼絲2條)			
	759000	1/2" 一字外牙(經濟型) 附塑膠法蘭蓋片			
	759001	1/2" 一字外牙(標準型) 附塑膠法蘭蓋片			
	759002	1/2" 一字外牙(加長型) 附ST法蘭蓋片			
	759003	1/2" 活動式三通接頭(經濟型)			
	759004	1/2" 三角外牙(經濟型) 附塑膠法蘭蓋片			
	759005	1/2" 水晶外牙(經濟型) 附塑膠法蘭蓋片			
	759100	1/2" 美規 內牙塑膠起波器(全流量)			
	759101	1/2" 美規 外牙塑膠起波器(全流量)			
	759200	3/8" 內牙-德製內膽銅起波器(全流量)			
	759201	3/8" 內牙-德製內膽銅起波器(2.2GPM)			
	759202	1/2" 內牙-德製內膽銅起波器(全流量)			
	759203	1/2" 內牙-德製內膽銅起波器(2.2GPM)			
	759204	3/8" 外牙-德製內膽銅起波器(全流量)			
	759205	3/8" 外牙-德製內膽銅起波器(2.2GPM)			
	759206	1/2" 外牙-德製內膽銅起波器(全流量)			
	759207	1/2" 外牙-德製內膽銅起波器(2.2GPM)			
	759208	3/4" 外牙-德製內膽銅起波器(全流量)			
	759209	1/2" 萬向接頭德製內膽外牙 單出水起波器(全流量)			

參考圖	品編	品名	盒 / 箱	牌價	折數
	759210	1/2" 萬向接頭德製內膽內外牙旋切 防滑雙出水水波器(1.8GPM)			
	759211	1/2" 內牙德製內膽防滑型 旋轉切換起波器(1.8GPM)			
	759212	1/2" 外牙德製內膽防滑型 旋轉切換起波器(1.8GPM)			
	790001	單段直管灰蓋-三件組	24		
	790002	單段直管圓灰白蓋蓮蓬頭-三件組	24		
	790003	單段直管圓灰蓋蓮蓬頭-三件組	24		
	790004	單段電鍍彎管黑蓋蓮蓬頭-三件組	24		
	790005	單段除垢直管深灰蓋蓮蓬頭-三件組	24		
	790006	單段除垢直管淺灰蓋蓮蓬頭-三件組	24		
	790007	三段按摩直管藍白蓋蓮蓬頭-三件組	24		
	790008	單段開關蓮蓬頭-三件組	24		



參考圖	品編	品名	盒 / 箱	牌價	折數
	790009	白色噴槍-三件組	30		
	790010	三段按摩直管純白蓋蓮蓬頭-三件組	24		
	790012	電鍍噴槍-三件組	30		
	791000	膠囊蓮蓬頭組合-珍珠白 (配件:玫瑰金軟管*1+治具*1+凝膠球*3)	12		
	791001	膠囊蓮蓬頭組合-玫瑰金 (配件:玫瑰金軟管*1+治具*1+凝膠球*3)	12		
	800309	奧茲塔籬笆-PP (24PCS/組)	8		
	801000	8M浪板10公分	12		
	801001	8M浪板15公分	12		
	801002	8M浪板20公分	12		
	801003	8M加強型浪板10公分	12		
	801004	8M加強型浪板15公分	12		

參考圖	品編	品名	盒 / 箱	牌價	折數
	812300	3*3模組盆栽 雙層-粉 德國紅點設計獎	8		
	812301	3*3模組盆栽 雙層-藍 德國紅點設計獎	8		
	812302	3*3模組盆栽 雙層-綠 德國紅點設計獎	8		
	812303	3*3模組盆栽 單層-黃 德國紅點設計獎	8		
	812310	3*3模組盆栽 單層-粉	12		
	812311	3*3模組盆栽 單層-藍	12		
	812312	3*3模組盆栽 單層-綠	12		
	812313	3*3模組盆栽 單層-黃	12		
	812320	小盆栽-粉	96		
	812321	小盆栽-藍	96		
	812322	小盆栽-綠	96		
	812323	小盆栽-黃	96		
	822401	13公分束帶	100/袋		
	822402	17公分束帶	100/袋		
	822403	23公分束帶	50/袋		
	823000	400米綠色繩			



參考圖	品編	品名	盒 / 箱	牌價	折數
	823100	100mm魔帶			
	823101	30mm魔帶			
	830000	直型花牌	25/袋		
	830006	方形花牌			
	850000	A 1/2"*100m單管噴水管帶	14		
	850100	B 1/2"*100m單管噴水管帶	14		
	850001	A 3/4"*100m單管噴水管帶	12		
	850101	B 3/4"*100m單管噴水管帶	12		
	850199	B 6.5"*100m單管噴水管帶	12		
	850002	A 1"*100m單管噴水管帶	10		
	850102	B 1"*100m單管噴水管帶	10		
	850003	A 1-1/4"*100m單管噴水管帶	8		
	850103	B 1-1/4"*100m單管噴水管帶	8		
	850004	A 1-1/2"*單管噴水管帶	6		
850104	B 1-1/2"*單管噴水管帶	6			
	851000	A 3/4"*2*100m雙管定位噴水管帶	5		
	851100	B 3/4"*2*100m雙管定位噴水管帶	5		
	852000	A 3/4"*100m三管定位噴水管帶	5		
	852100	B 3/4"*100m三管定位噴水管帶	5		
	852001	A 1"*100m三管定位噴水管帶	5		
	852101	B 1"*100m三管定位噴水管帶	5		
	852002	A 1-1/4"*100m三管定位噴水管帶	5		
	852102	B 1-1/4"*100m三管定位噴水管帶	5		
	853000	A 3/4"*100m雙翼定位噴水管帶	8		
	853100	B 3/4"*100m雙翼定位噴水管帶	8		
	853001	A 1"*100m雙翼定位噴水管帶	6		
	853101	B 1"*100m雙翼定位噴水管帶	6		
	853002	A 1-1/4"*100m雙翼定位噴水管帶	6		
	853102	B 1-1/4"*100m雙翼定位噴水管帶	6		
	853003	A 1-1/4"*100m雙翼吊式噴水管帶	6		
	853103	B 1-1/4"*100m雙翼吊式噴水管帶	6		
	854000	A 1/2"*100m無孔排水管帶	14		
	854100	B 1/2"*100m無孔排水管帶	14		
854001	A 3/4"*100m無孔排水管帶	12			
854101	B 3/4"*100m無孔排水管帶	12			
854002	A 1"*100m無孔排水管帶	10			
854102	B 1"*100m無孔排水管帶	10			
854003	A 1-1/4"*100m無孔排水管帶	8			
854103	B 1-1/4"*100m無孔排水管帶	8			
854004	A 1-1/2"*100m無孔排水管帶	6			

參考圖	品編	品名	盒 / 箱	牌價	折數
	854104	B 1-1/2"*100m無孔排水管帶	6		
	854005	A 2"*100m無孔排水管帶	5		
	854105	B 2"*100m無孔排水管帶	5		
	854006	A 2-1/2"*100m無孔排水管帶	4		
	854106	B 2-1/2"*100m無孔排水管帶	5		
	854007	A 3"*100m無孔排水管帶	3		
	854107	B 3"*100m無孔排水管帶	4		
	854008	A 3-1/2"*100m無孔排水管帶	3		
	854108	B 3-1/2"*100m無孔排水管帶	3		
	854009	A 4"*100m無孔排水管帶	3		
	854109	B 4"*100m無孔排水管帶	3		
	854010	A 5"*100m無孔排水管帶	2		
	854110	B 5"*100m無孔排水管帶	2		
	854011	A 6"*100m無孔排水管帶	2		
	854111	B 6"*100m無孔排水管帶	2		
854012	A 7"*100m無孔排水管帶	2			
854112	B 7"*100m無孔排水管帶	2			
854013	A 8"*100m無孔排水管帶	1			
854113	B 8"*100m無孔排水管帶	1			
	855000	A 3/4"透明藍單管噴水管	12		
	855100	B 3/4"透明藍單管噴水管	12		
	855001	A 1"透明藍單管噴水管	10		
	855101	B 1"透明藍單管噴水管	10		
855002	A 1-1/4"透明藍單管噴水管	8			
855102	B 1-1/4"透明藍單管噴水管	8			
	859000	2"*1 1/4" male thread 三通接頭	100		
	859001	2 1/2"*1 1/4" male thread 三通接頭	85		
	859002	3"*1 1/4" male thread 三通接頭	55		
	859003	3 1/2"*1 1/4" male thread 三通接頭	45		
859004	4"*1 1/4" male thread 三通接頭	40			
	859100	2"*1 1/4" male thread 四通接頭	100		
	859101	2 1/2"*1 1/4" male thread 四通接頭	75		
	859102	3"*1 1/4" male thread 四通接頭	50		
	859103	3 1/2"*1 1/4" male thread 四通接頭	40		
	859104	4"*1 1/4" male thread 四通接頭	35		
	859200	3/4" male thread*3/4" 管首快接頭	500		
	859201	1 1/4" male thread *1" 管首快接頭	500		
	859202	1 1/4" male thread*1 1/4" 管首快接頭	400		
	859210	3/4"*3/4"管中雙環快接頭	500		
	859211	1" *1"管中雙環快接頭	500		
	859212	1 1/4"*1 1/4"管中雙環快接頭	400		
	859220	1 1/4" male thread*3/4"*2管首Y快接頭	250		
	859900	1 1/4" male thread 止水帽內螺牙	1000		
	859901	噴水管帶折彎固定插6mm*1.5尺	1000		
	859902	固定3孔止水尾夾	600		
	859903	無固定孔止水尾夾	660		



參考圖	品編	品名	盒 / 箱	牌價	折數
	859904	1-1/4"內牙*3/4"外牙大小頭			
	860000	三段塑槍			
	860001	七段塑槍			
	860002	三段直塑槍-奶嘴型			
	860003	三段直塑槍-內牙型			
	860004	尖嘴5點塑槍			
	860005	尖嘴水波塑槍(奶嘴型)			
	860006	10段5點塑槍(奶嘴型)			
	860007	10段水波塑槍(奶嘴型)			
	860008	4-1/2"無牙塑槍			
	860100	銅頭前壓鋅槍			
	860101	銅頭L型後壓鋅槍			
	860102	3線小銅頭後壓鋅槍			
	860103	10段前壓鋅槍			

參考圖	品編	品名	盒 / 箱	牌價	折數
	860104	10段L型後壓鋅槍			
	860105	5-1/2"有牙鋅槍			
	861000	三臂旋轉灑水噴頭			
	862000	3/8"快速接頭			
	862001	1/2"快速接頭-止水			
	862002	1/2"快速接頭-不止水			
	862003	3/4"快速接頭-止水			
	862004	3/4"快速接頭-不止水			
	862005	3/4"內牙快速接頭-止水			
	862006	3/4"內牙快速接頭-不止水			
	862007	3/4"外牙快速接頭			
	862100	1/2"公牙接頭			
	862101	3/4"公牙接頭			
	862102	1/2"母牙接頭			
	862103	3/4"母牙接頭			
	862104	1/2"雙邊接頭			
	862105	3/4"雙邊接頭			
	862106	1/2" & 5/8" & 3/4" 合蓋公牙 (含一般螺絲不包含組裝)			
	862107	1/2" & 5/8" & 3/4" 合蓋母牙 (含一般螺絲不包含組裝)			
	862108	1/2" & 5/8" & 3/4" 雙邊合蓋 (含一般螺絲不包含組裝)			

















參考圖	品編	品名	盒 / 箱	牌價	折數
	862109	3/8"水管接頭組			
	862200	1/2"&3/4"水龍頭接頭(含鍊子)			
	862201	1/2"&3/4"水龍頭接頭			
	862202	3/4"水龍頭接頭			
	862203	3/4"水龍頭接頭			
	862300	3/4"外牙奶嘴			
	862301	3/4"母牙奶嘴			
	862302	1"母牙奶嘴			
	862303	3/4"雙頭奶嘴			
	862304	三通奶嘴			
	862305	3/4"~1/2"轉接器			
	862306	1"~3/4"轉接器			
	862307	3/4"奶嘴單通開關			
	862308	3/4"外牙單通開關			
	862309	3/4"奶嘴雙通開關			
	862310	3/4"外牙雙通開關			
	862311	雙通無開關接頭			
	868000	4段直噴水槍接頭組			

參考圖	品編	品名	盒 / 箱	牌價	折數
	868001	4段後推水槍接頭組			
	868100	7.5米伸縮布管組			
	868101	10米花園水管組			
	869000	J型水管架			
	869001	掛座(含一般螺絲)			
	869002	布管內牙			
	869003	布管外牙			
	869004	布管護套			
	869005	牙護套			
	869006	老鼠尾			
	869007	無孔油任			
	869008	有孔油任			
	869009	1/2"墊片			
	869010	3/4"墊片			
	869011	1"墊片			
	869012	吊卡			



參考圖	品編	品名	盒 / 箱	牌價	折數
	900103	提盒(大)(145mm*110mm*135mm)			
	900104	提盒(中)(145mm*110mm*85mm)			
	900105	提盒(小)(145mm*110mm*55mm)			
	900106	側扣盒			
	900107	吊耳側扣盒			
	900108	弧底盒			
	900109	雙腳盒小			
	900110	雙腳盒大			
	900111	吊耳四格盒			
	910000				
	910100	章魚掛勾-白鐵勾(白)	2PCS/盒		
	910200		100PCS/盒		

參考圖	品編	品名	盒 / 箱	牌價	折數
	910001				
	910101	章魚掛勾-白鐵勾(黑)	2PCS/盒		
	910201		100PCS/盒		
	910002				
	910102	章魚掛勾-白鐵勾(粉)	2PCS/盒		
	910202		100PCS/盒		
	910003				
	910103	章魚掛勾-白鐵勾(藍)	2PCS/盒		
	910203		100PCS/盒		
	910204	章魚掛勾(四色各25入)	100PCS/盒		
	910004				
	910104	章魚掛勾-塑膠單勾(白)	2PCS/盒		
	910005				
	910105	章魚掛勾-塑膠單勾(粉)	2PCS/盒		
	910006				
	910106	章魚掛勾-塑膠單勾(藍)	2PCS/盒		
	910007				
	910107	章魚掛勾-塑膠雙勾(白)	2PCS/盒		
	910008				
	910108	章魚掛勾-塑膠雙勾(粉)	2PCS/盒		
	910009				
	910109	章魚掛勾-塑膠雙勾(藍)	2PCS/盒		
	910501	章魚肥皂架-塑膠(白)	1PC/盒		
	910502	章魚肥皂架-塑膠(粉)	1PC/盒		
	910503	章魚肥皂架-塑膠(藍)	1PC/盒		
	950000	護膝軟墊	1 SET/袋		





Made in Taiwan

Since 1978

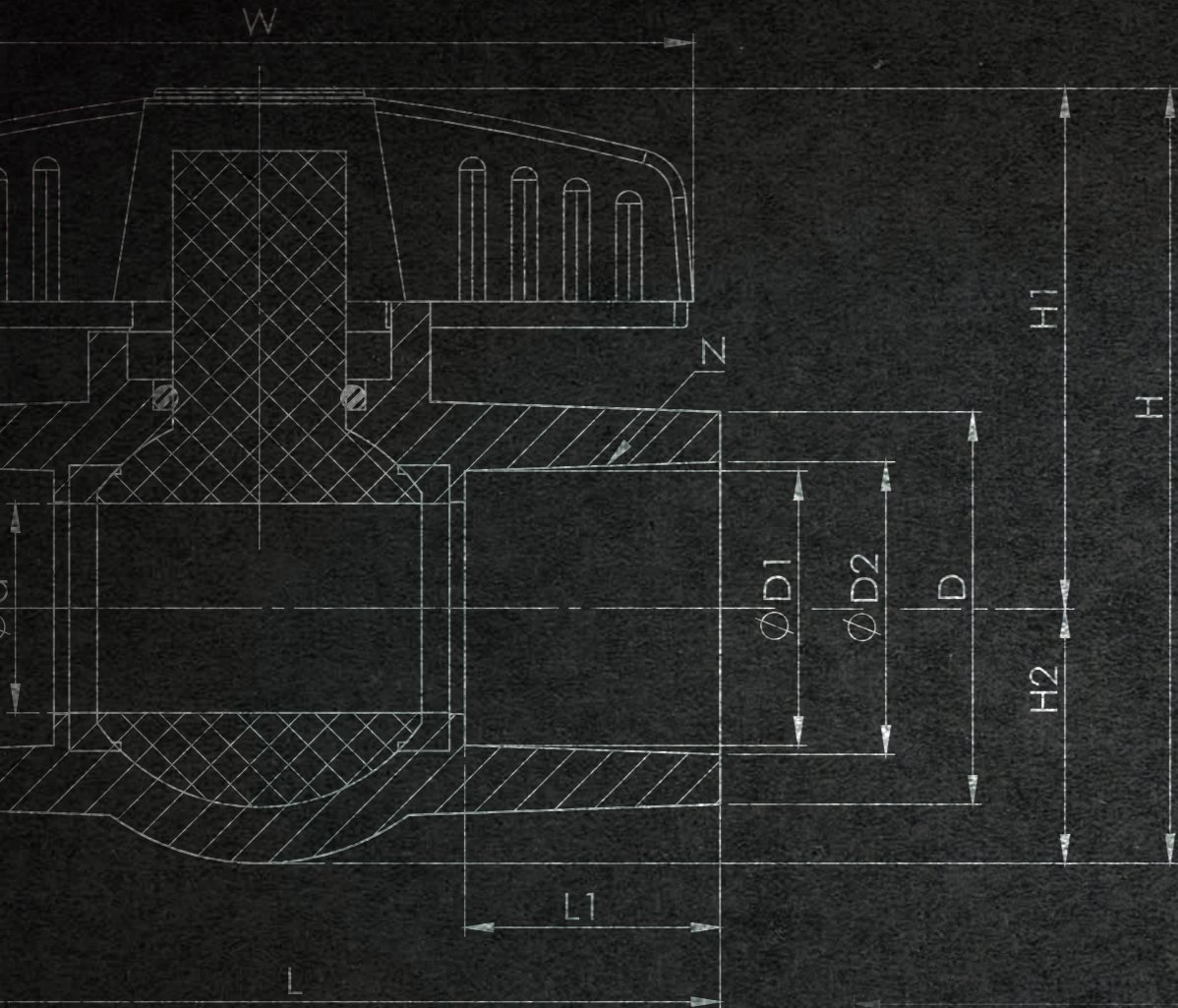

TEL : 04-7616616 | FAX : 04-7616615

地址：彰化縣秀水鄉雅興街178巷20號

E-Mail : mail@chiutong.com

網址：http://chiutong.com

久統塑膠 X 2019

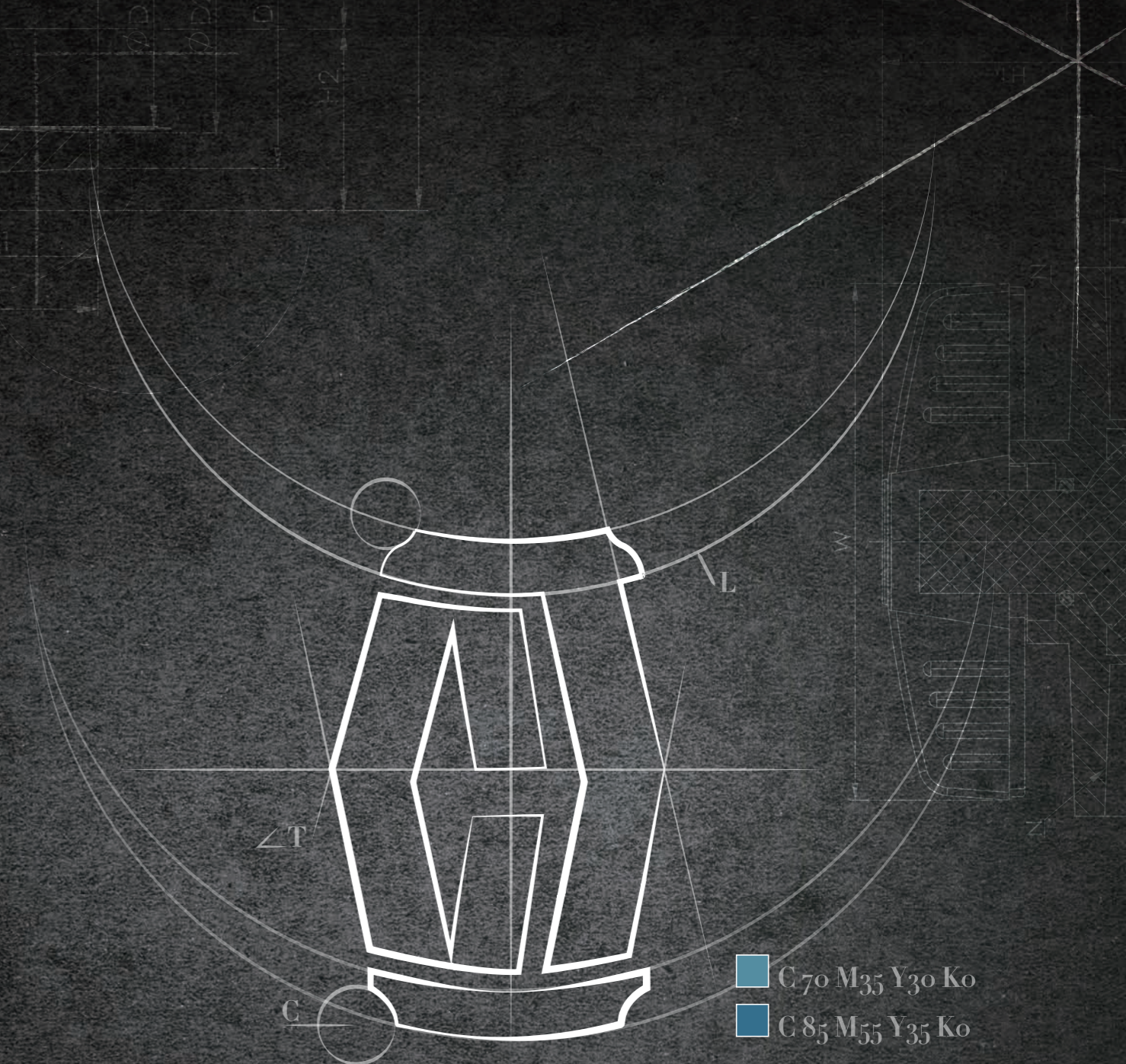

久統塑膠有限公司

CHIUTONG

We only pursue perfection

2019

CHIUTONG